



EVOLUTIONSERIES

INSTALLATION AND OPERATION MANUAL

GAS CONVECTION OVEN RANGE

G54
G56
G58



Date Purchased _____

Serial Number _____

Dealer _____

Service Provider _____

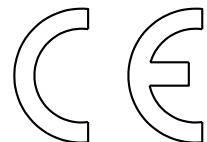

For use in GB, IE & DK

230105-11

MANUFACTURED BY

Moffat Limited
PO Box 10001
Christchurch
New Zealand
Ph: (03) 389 1007
Fax: (03) 389 1276

WORLD-WIDE BRANCHES**UNITED KINGDOM**

Blue Seal
Unit 67, Gravelly Business Park
Gravelly Park
Birmingham
West Midlands
B24 8TQ
Ph: (121) 327 5575
Fax: (121) 327 9711

UNITED STATES

Moffat Inc
3765 Champion Blvd
Winston-Salem
North Carolina 27115
Ph: (336) 661 0257
Fax: (336) 661 9546

CANADA

Serve Canada
22 Ashwarren Road
Downview
Ontario M3J1Z5
Toll Free:800 263 1455
Ph: (416) 631 0601
Fax: (416) 631 0315
info@servecanada.com
www.servecanada.com
www.moffat.com

NEW ZEALAND**Christchurch**

Moffat Limited
PO Box 10-001
16 Osborne Street
Christchurch
Ph: (03) 389 1007
Fax: (03) 389 1276

Auckland

Moffat Limited
4 Waipuna Road
Mt Wellington
Auckland
Ph: (09) 574 3150
Fax: (09) 574 3159

AUSTRALIA**Victoria**

Moffat Pty Limited
740 Springvale Road
Mulgrave, Melbourne
Victoria 3171
Ph: (03) 9518 3888
Fax: (03) 9518 3838

New South Wales

Moffat Pty Limited
3/142 James Ruse Drive, Rose Hill
PO Box 913, Smithfield
Sydney, N.S.W. 2142
Ph: (02) 8833 4111
Fax: (02) 8833 4133

Western Australia

Moffat Pty Limited
67 Howe Street
Osbourne Park
WA 6017
Ph: (08) 9202 6820
Fax: (08) 9202 6836

Queensland

Moffat Pty Limited
30 Prosperity Place
Geebung, Brisbane
Queensland 4034
Ph: (07) 3630 8600
Fax: (07) 3630 8623

The reproduction or copying of any part of this manual by any means whatsoever is strictly forbidden unless authorized previously in writing by the manufacturer.

In line with policy to continually develop and improve its products, Moffat Ltd. reserves the right to change the specifications and design without prior notice.

Blue Seal Gas Range Convection Oven

- G54** **Gas Convection Oven Range - 750 mm wide.**
- G56** **Gas Convection Oven Range - 900 mm wide.**
- G58** **Gas Convection Oven Range - 1200 mm wide.**

Introduction	2
Specification	3
Model Numbers Covered in this Specification	
General	
Gas Supply Requirements	
Gas Connection	
Electrical Supply Requirements	
Dimensions	5
Installation	8
Installation Requirements	
Unpacking	
Location	
Clearances	
Assembly	
Gas Connection	
Electrical Connection	
Commissioning	
Operation	11
Operation Guide	
Description of Controls	
Open Burners	
Griddles	
Oven Pilot Ignition	
Oven - Main Burner / Thermostat	
Oven Fan	
Turning the Oven to 'Stand-By' (Pilot 'ON' Only)	
Oven 'Shut Down'	
Cleaning and Maintenance	15
General	
After Each Use	
Daily Cleaning	
Weekly Cleaning	
Periodic Maintenance	
Fault Finding	19
Wiring Schematic.....	20
Gas Conversion and Specifications.....	21
Conversion Procedure	
Gas Specifications	
Replacement Parts List.....	28

Introduction

We are confident that you will be delighted with your BLUE SEAL Gas Range Convection Oven , , and it will become a most valued appliance in your commercial kitchen.

To ensure you receive the utmost benefit from your new Blue Seal appliance, there are two important things you can do.

Firstly:

Please read the instruction book carefully and follow the directions given. The time taken will be well spent.

Secondly:

If you are unsure of any aspect of the installation, instructions or performance of your appliance, contact your BLUE SEAL dealer promptly. In many cases a phone call could answer your question.

CE Only:

These instructions are only valid if the country code appears on the appliance. If the code does not appear on the appliance, refer to the supplier of this appliance to obtain the technical instructions for adapting the appliance to the conditions for use in that country.

WARNING:

IMPROPER INSTALLATION, ADJUSTMENT, ALTERATION, SERVICE OR MAINTENANCE CAN CAUSE PROPERTY DAMAGE, INJURY OR DEATH. READ THE INSTALLATION, OPERATING AND MAINTENANCE INSTRUCTIONS THOROUGHLY BEFORE INSTALLING OR SERVICING THIS APPLIANCE.

WARNING:

INSTRUCTIONS TO BE FOLLOWED IN THE EVENT THE USER SMELLS GAS ARE TO BE POSTED IN A PROMINENT LOCATION. THIS INFORMATION SHALL BE OBTAINED BY CONSULTING THE LOCAL GAS SUPPLIER.

WARNING:

GREAT CARE MUST BE TAKEN BY THE OPERATOR TO USE THE EQUIPMENT SAFELY TO GUARD IT AGAINST RISK OF FIRE.

- **THE APPLIANCE MUST NOT BE LEFT 'ON' UNATTENDED.**
- **IT IS RECOMMENDED THAT A REGULAR INSPECTION IS MADE BY A COMPETENT SERVICEMAN TO ENSURE CORRECT AND SAFE OPERATION OF YOUR APPLIANCE IS MAINTAINED.**
- **DO NOT STORE OR USE GASOLINE OR OTHER FLAMMABLE VAPOURS OR LIQUIDS IN THE VICINITY OF THIS OR ANY OTHER APPLIANCE.**
- **DO NOT SPRAY AEROSOLS IN THE VICINITY OF THIS APPLIANCE WHILE IT IS IN OPERATION.**

CAUTION:

This appliance is;

- **For professional use and is to be used by qualified persons only.**
- **Only authorised service persons are to carry out installation, servicing and gas conversion operations.**
- **Components having adjustments protected (e.g. paint sealed) by the manufacturer should not be adjusted by the user / operator.**
- **DO NOT operate the appliance without the legs supplied fitted.**

Model Numbers Covered in this Specification

- G54D[1] 4 Open Burners + Turbofan Convection Oven.
- G54C[1] 2 Open Burners + 300 mm Griddle + Turbofan Convection Oven.

- G56D[1] 6 Open Burners + Turbofan Convection Oven.
- G56C[1] 4 Open Burners + 300 mm Griddle + Turbofan Convection Oven.
- G56B[1] 2 Open Burners + 600 mm Griddle + Turbofan Convection Oven.
- G56A 900 mm Griddle + Turbofan Convection Oven.

- G58D[1] 8 Open Burners + Turbofan Convection Oven.
- G58C[1] 6 Open Burners + 300 mm Griddle + Turbofan Convection Oven.
- G58B[1] 4 Open Burners + 600 mm Griddle + Turbofan Convection Oven.
- G58A 2 Open Burners + 900 mm Griddle + Turbofan Convection Oven.

[1] - Open Burner Options;

- F - With Flame Failure Protection.
- PF - With Pilot and Flame Failure Protection.

General

A heavy duty, general purpose gas range created for compact modular kitchens. It has a high option Cook Top / Griddle arrangement and is available on industrial adjustable feet or on robust rollers. Open Burners are available in either 'PF' (Pilot and Flame Failure) or 'F' (Flame Failure Only) options. Open Burner and Griddle options are fitted with individual flame failure for each open burner. Griddles are fitted with pilot, flame failure and piezo ignition as standard. The range is fitted with a turbofan convection oven which has pilot and flame failure with piezo ignition.

Easy clean stainless external finish.

Gas Supply Requirements

- Non CE Only

	Natural Gas	LP Gas (Propane)
Input Rate (N.H.G.C.)		
- each Open Burner	28 MJ/hr (26,540 Btu/hr)	28 MJ/hr (26,540 Btu/hr)
- each 300 mm Griddle Section	21 MJ/hr (19,900 Btu/hr)	21 MJ/hr (19,900 Btu/hr)
- Oven	30 MJ/hr (28,434 Btu/hr)	30 MJ/hr (28,434 Btu/hr)
Supply Pressure	1.13 - 3.40 kPa (4.5" - 13.5" w.c.)	2.75 - 4.50 kPa (11" - 18.0" w.c.)
Operating Pressure	0.95 kPa (*) (3.7" w.c.)	2.6 kPa (*) (10.0" w.c.)
Gas Connection	$\frac{3}{4}$ " B.S.P. Male	

Specifications

- CE Only:

Appliance Classification

Category: **II_{2H3P} (20, 30 / 37).**

Flue Type: **A₁.**

		Natural Gas (G20)			Propane (G31)		
		Open Burner (each)	Griddle (each 300mm section)	Oven	Open Burner (each)	Griddle (each 300mm section)	Oven
Heat Input (nett)	Nominal	6.5 kW	5.5 kW	7.8 kW	6.5 kW	5.5 kW	7.8 kW
	Reduced	1.75 kW	1.85 kW	---	1.75 kW	1.95 kW	---
Gas Rate (nett)	Nominal	0.69 m ³ /hr	0.58 m ³ /hr	0.83 m ³ /hr	0.51 kg/hr	0.43 kg/hr	0.61 kg/hr
	Reduced	0.19 m ³ /hr	0.20 m ³ /hr	---	0.14 kg/hr	0.15 kg/hr	---
Supply Pressure		20 mbar			30 / 37 mbar		
Operating Pressure		9.5 mbar (*)			26 mbar (*)		
Gas Connection		3/4" B.S.P. Male					

- * The burner operating pressure is to be measured at the manifold test point with two burners operating at full setting. The operating pressure is ex-factory set through the appliance regulator and is not to be adjusted, apart from when carrying out gas conversion, if required. (Refer to the 'Gas Conversion' section for details).

Gas Connection

Gas supply connection point is located at the rear of the appliance, approximately 130 mm from the right hand side, 35 mm from the rear and 655 mm from the floor and is reached from beneath the appliance. (Refer to the 'Dimensions' section).

Connection is 3/4" BSP male thread.

Electrical Supply Requirements

230-240 V a.c, 50 Hz, 1.6A, 1P+N+E.
0.4kW.

Oven Fan Motor - 100W.

Dimensions G54

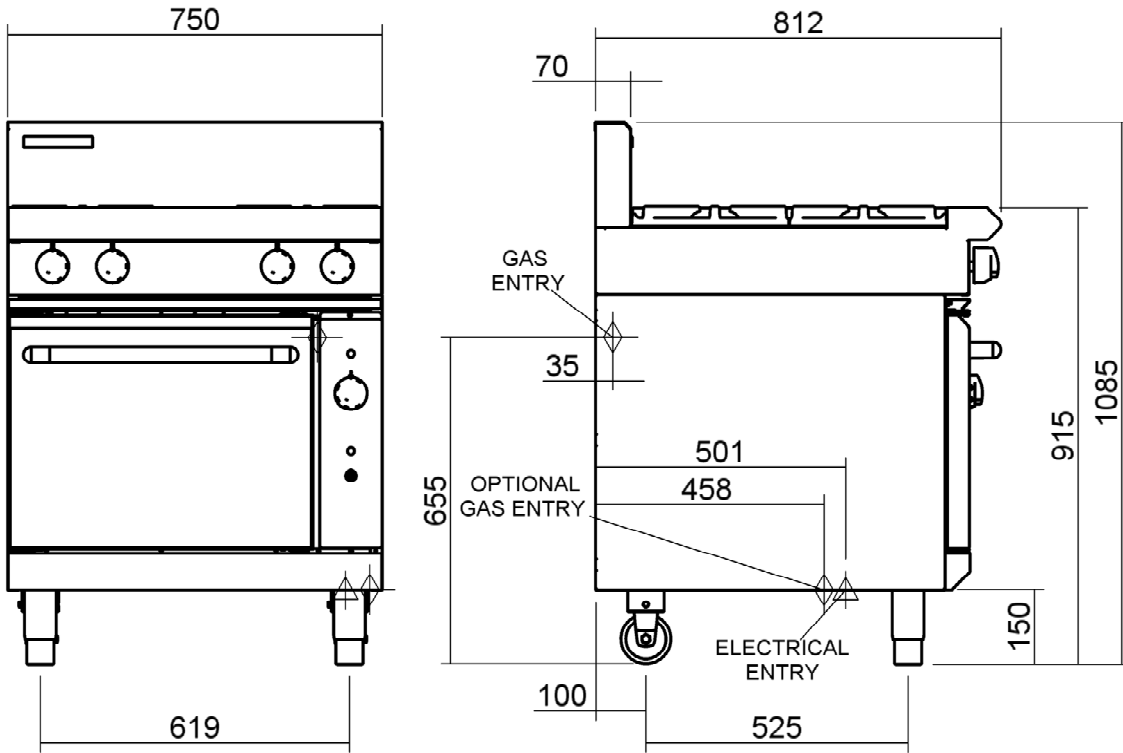

Cook Top Options G54D

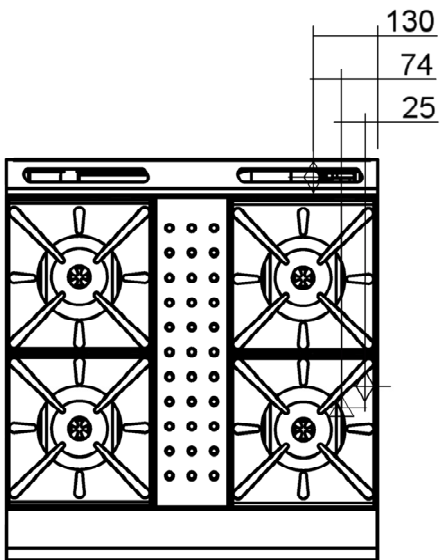

Cook Top Options G54C

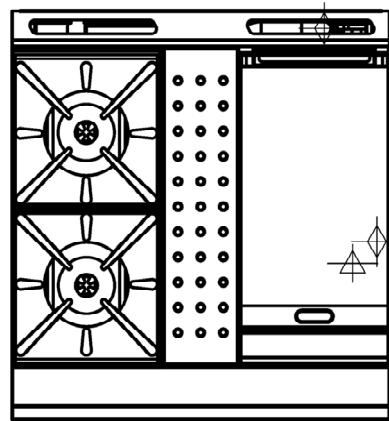

Dimensions

Dimensions G56D, G56C, G56B & G56A Models

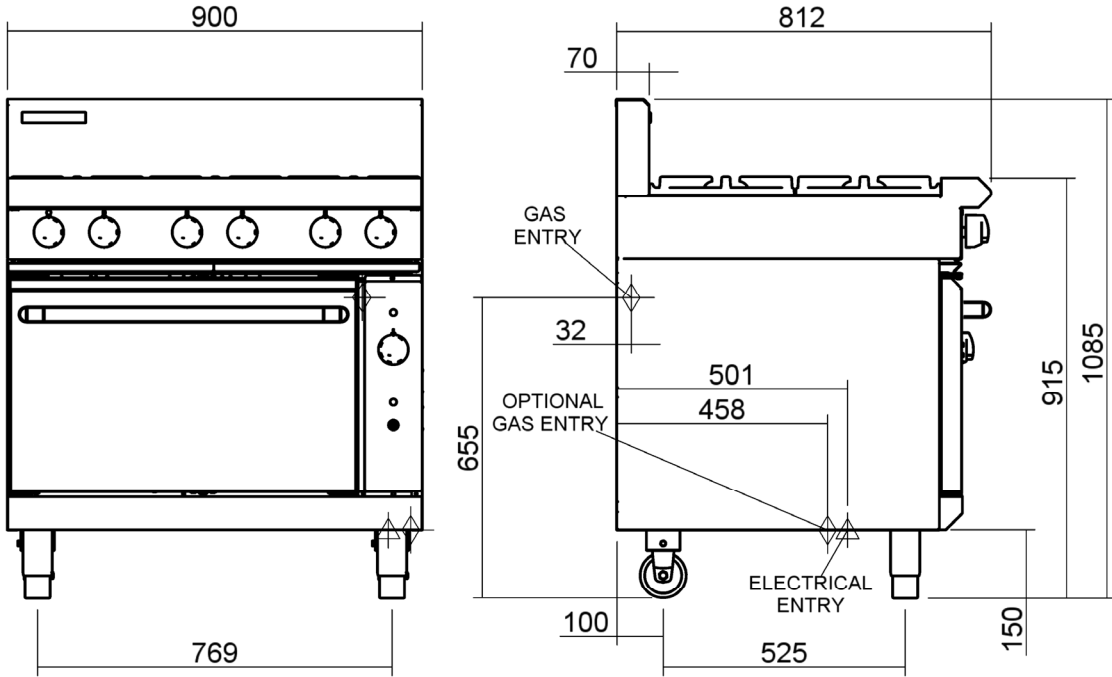

Cook Top Options G56D

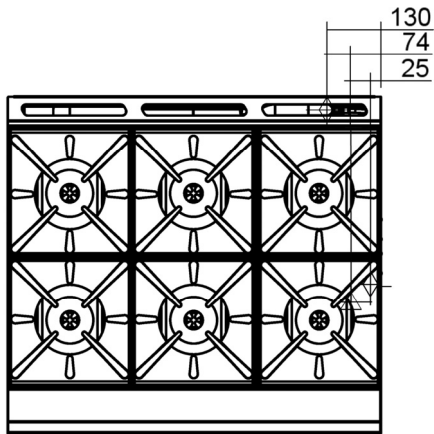

Cook Top Options G56C

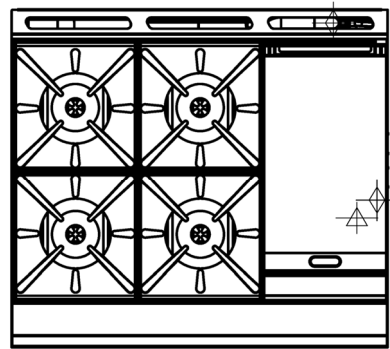

Cook Top Options G56B

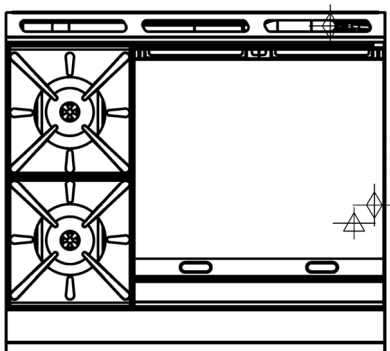

Cook Top Options G56A

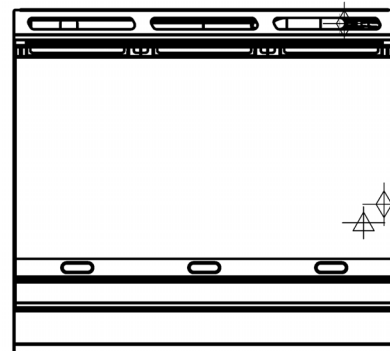

Dimensions

Dimensions G58D, G58C, G58B & G58A Models

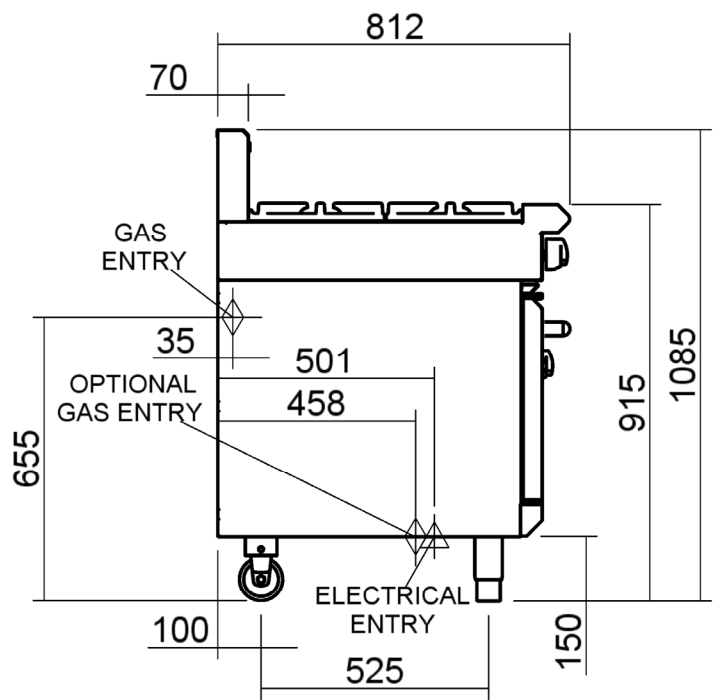
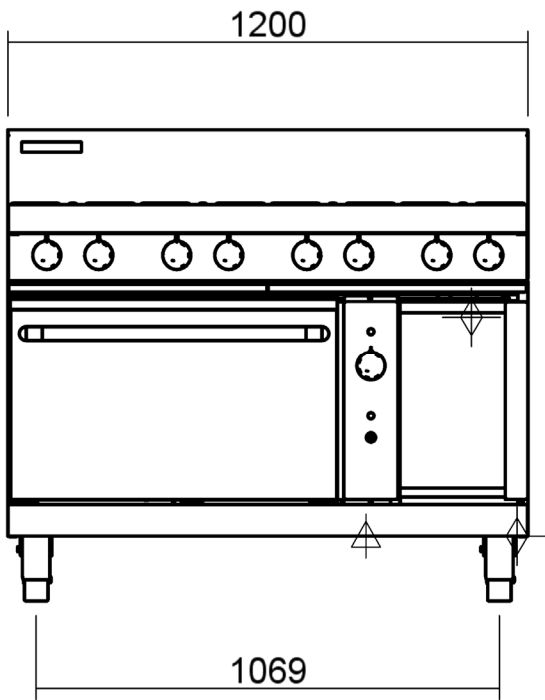

Cook Top Options G58D

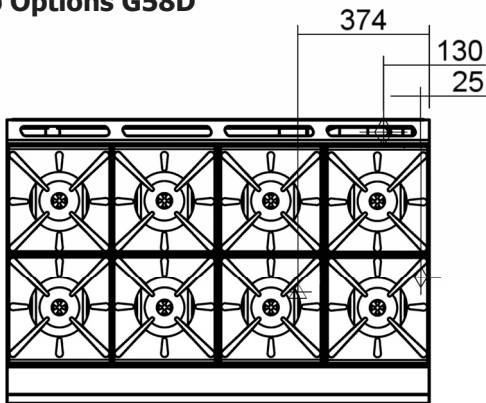

Cook Top Options G58C

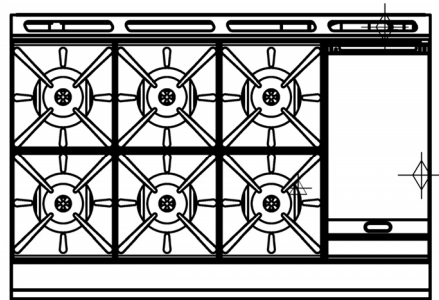

Cook Top Options G58B

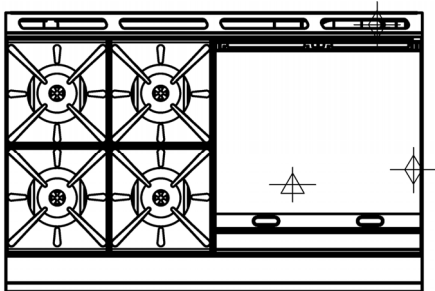

Cook Top Options G58A

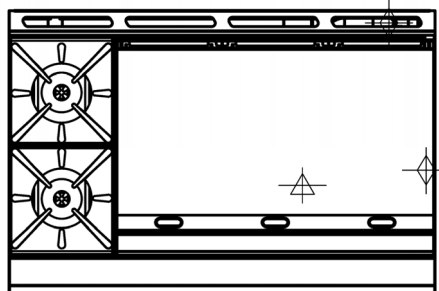

Installation

Installation Requirements

NOTE:

- It is most important that this appliance is installed correctly and that operation is correct before use. Installation shall comply with local gas, electrical and health and safety requirements.
- This appliance shall be installed with sufficient ventilation to prevent the occurrence of unacceptable concentrations of health harmful substances in the room, the appliance is installed in.

Blue Seal gas Range Convection Ovens are designed to provide years of satisfactory service, and correct installation is essential to achieve the best performance, efficiency and trouble-free operation. This appliance must be installed in accordance with National installation codes and in addition, in accordance with relevant National / Local codes covering gas, electrical and fire safety.

AUSTRALIA:	- AS 5601	- Gas Installations.
NEW ZEALAND:	- NZS 5261	- Gas Installation.
Australia / New Zealand:	- AS/NZS 3000	- Wiring Rules.
UNITED KINGDOM:	- Gas Safety (Installation & Use) Regulations 1998.	
	- BS 6173	- Installation of Catering Appliances.
	- BS 5440 1 & 2	- Installation Flueing & Ventilation.
	- BS 7671	- Requirements for Electrical Installation.
IRELAND:	- IS 820	- Non - Domestic Gas Installations.

Installations must be carried out by authorised persons only. Failure to install equipment to the relevant codes and manufacturer's specifications shown in this section will void the warranty.

Components having adjustments protected (e.g. paint sealed) by the manufacturer are only to be adjusted by an authorised service agent. They are not to be adjusted by the installation person.

Unpacking

- Remove all packaging and transit protection from the appliance including all protective plastic coating from the exterior stainless steel panels.
- Check equipment and parts for damage. Report any damage immediately to the carrier and distributor.
- Report any deficiencies to the distributor who supplied the appliance.
- Check that the available gas and electrical supply is correct to that shown on the rating plate located on the front right hand corner of the bottom sill.

Location

1. Installation must allow for a sufficient flow of fresh air for the combustion air supply.

Combustion Air Requirements:			
	G54	G56	G58
Natural Gas (G20)	37 m ³ /hr	51 m ³ /hr	66 m ³ /hr
LPG (G31)	38 m ³ /hr	53 m ³ /hr	68 m ³ /hr

2. Installation must include adequate ventilation means, to prevent dangerous build up of combustion products.
3. Never directly connect a ventilation system to the appliance flue outlet.
4. Position the appliance in its approximate working position.
5. All air for burner combustion is supplied from underneath the appliance. The legs must always be fitted and no obstructions placed on the underside or around the base of the appliance, as obstructions will cause incorrect operation and/or failure of the appliance.

NOTE: Do not obstruct or block the appliances flue. Never directly connect a ventilation system to the appliance flue outlet.

Clearances

NOTE: Only non-combustible materials can be used in close proximity to this appliance.

	Combustible Surface	Non Combustible Surface
Left/Right hand side	250 mm (*)	0 mm
Rear	100 mm	0 mm

* Side clearances can be 50 mm when the adjacent surface is at least 100 mm below the cooking surface.

Assembly

All Models are delivered completely assembled. No further assembly is required. Refer to the information below for assembly instructions.

NOTE:

- **All Models are delivered completely assembled. No further assembly is required. Refer to the information below for assembly instructions.**
- **This appliance is fitted with adjustable feet to enable the appliance to be positioned securely and level. This should be carried out on completion of the gas connection. Refer to the 'Gas Connection' section.**

Optional Accessories (Refer to Replacement Parts List)

- Plinth Kit. For installation details, refer to the instructions supplied with each kit.
- Rear Adjustable Legs.

1. Check that all the feet (or castors) are securely fitted.
2. Adjust the feet to make the convection oven range steady and level.

Gas Connection

NOTE: ALL GAS FITTING MUST ONLY BE CARRIED OUT BY AN AUTHORISED PERSON.

1. It is essential that the gas supply is correct for the appliance to be installed and that adequate supply pressure and volume are available. The following checks should therefore be made before installation:-
 - a. **Gas Type** the appliance has been supplied for is shown on coloured stickers located above the gas connection and next to the rating plate. Check that this is correct for the gas supply the appliance is being installed for. The gas conversion procedure is detailed in this manual.
 - b. **Supply Pressure** required for this appliance is shown in the 'Specifications' section of this manual. Check the gas supply to ensure adequate supply pressure exists.
 - c. **The Input Rate** of this appliance is stated on the Rating Plate and in the 'Specifications' section of this manual. The input rate should be checked against the available gas supply line capacity. **Particular note should be taken if the appliance is being added to an existing installation.**



NOTE: It is important that adequately sized piping runs directly to the connection joint on the appliance with as few tees and elbows as possible to give maximum supply volume.

2. Fit the gas regulator supplied, into the gas supply line as close to the appliance as possible.

NOTE: The gas pressure regulator provided with this appliance is convertible between Natural Gas and LPG as per the 'Gas Conversion Section' in this manual. Ensure the regulator is converted to the correct gas type that the appliance will operate on. The regulator outlet pressure is fixed ex-factory for the gas type that the regulator is converted to and it is NOT to be adjusted.

Installation

The regulator connections are $\frac{3}{4}$ " BSP female.

The connection to the appliance is $\frac{3}{4}$ " BSP male.

(Refer to the "Specifications" section for the gas supply location dimensions).

NOTE: A Manual Isolation Valve must be fitted to the individual appliance supply line.

3. Correctly locate the appliance into its final operating position and using a spirit level, adjust the legs so that the appliance is level and at the correct height.
4. Connect the gas supply to the appliance. A suitable jointing compound which resists the breakdown action of LPG must be used on every gas line connection, unless compression fittings are used.
5. Check all gas connections for leakages using soapy water or other gas detecting equipment.

WARNING:

DO NOT USE A NAKED FLAME TO CHECK FOR GAS LEAKAGES.

6. Check that the gas operating pressure is as shown in the 'Specifications' section.

NOTE: The burner operating pressure is to be measured at the manifold test point with two burners operating at 'Full' setting.

7. Turn 'OFF' the mains gas supply and bleed the gas out of the appliance gas lines.
8. Turn 'ON' the gas supply and the appliance.
9. Verify the operating pressure remains correct.

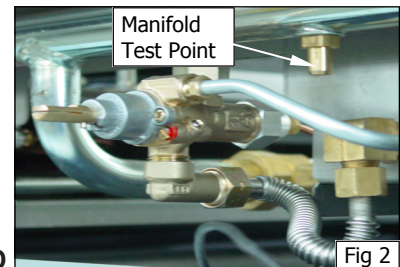

Electrical Connection

NOTE: ALL ELECTRICAL CONNECTIONS MUST ONLY BE CARRIED OUT BY AN AUTHORISED PERSON.

Each appliance should be connected to an adequately protected power supply and isolation switch mounted adjacent to, but not behind the appliance. This switch must be clearly marked and readily accessible in case of fire.

1. Check that the electricity supply is correct as shown on the Rating Plate attached to the front right hand corner of the bottom sill.
2. The appliance is fitted with a 10 Amp, 3 pin plug cordset for connection to a properly earthed, 3 pin switched electrical socket.

Commissioning

1. Before leaving the new installation;
 - a. Check the following functions in accordance with the operating instructions specified in the "Operation" section of this manual.
 - Lighting the Griddle.
 - Light the Open Burners. (F - Flame Failure Option).
 - Light the Open Burners. (PF - Pilot and Flame Failure Option).
 - Check the Low Fire Burner operation.
 - Check the High Fire Burner operation.
 - Light the Oven Pilot and Main Burners.
 - Check the Oven Main Burner Thermostat operation.
 - Check the Oven Fan operation.
 - b. Ensure that the operator has been instructed in the areas of correct lighting, operation, and shutdown procedure for the appliance.
2. This manual must be kept by the owner for future reference, and a record of the **Date of Purchase, Date of Installation** and **Serial Number of the Appliance** recorded and kept with this manual. (**These details can be found on the Rating Plate attached to the front right hand corner of the bottom sill. Refer to the 'Gas Connection' section**).

NOTE: If for some reason it is not possible to get the appliance to operate correctly, shut off the gas supply and contact the supplier of this appliance.

Operation Guide

CAUTION:

- This appliance is for professional use and is only to be used by qualified people.
- Only authorised service persons should be used to carry out installation, servicing or gas conversion operations.
- Components having adjustments protected (e.g. paint sealed) by the manufacturer should not be adjusted by the user / operator.

1. Blue Seal appliances have been designed to provide simplicity of operation and 100% safety protection.
2. Improper operation is therefore almost impossible, however bad operation practices can reduce the life of the appliance and produce a poor quality product. To use this appliance correctly please read the following sections carefully:-

- Lighting the Open Burners (F - Flame Failure Option).
- Lighting the Open Burners (PF - Pilot and Flame Failure Option).
- Lighting the Griddles (If fitted).
- Oven Pilot Ignition.
- Oven Main Burner / Thermostat.
- Oven Fan.
- Turning Oven to 'Stand-By' Mode.
- Oven 'Shut-Down'.

Description of Controls



Gas Control Knobs

Griddle Option

Burner Control

- OFF Position
- ★ PILOT Burner
- △ HIGH Flame
- ▽ LOW Flame

Piezo Igniter (Griddle)
(Located here when fitted with Griddle Option)

Oven Thermostat
Temperature Graduations 50°C to 320°C

Oven Gas Control

- OFF Position
- ★ PILOT Burner
- △ HIGH Flame

Open Burner Option

- OFF Position
- △ HIGH Flame
- ▽ LOW Flame
- △ Rear Burner
- ▽ Front Burner

(Indicators located above the Gas Control Knobs).

Heating Indicator Lamp (Amber)

Power Indicator Lamp (White)

Piezo Igniter (Oven)

Operation

Open Burners

NOTE: Only cooking pans from size Ø 150 mm to Ø 420 mm are suitable for use on these open burners.

Flame Failure Option (F-Models)

Lighting the Open Burners

Flame Failure Protection is incorporated for each burner by way of a thermo-electric system which will shut off the gas supply to that burner in the event that the burner goes out, so that un-burnt gas is not expelled.

- a. Select the burner required, depress and turn the corresponding gas control knob anti-clockwise to the 'HIGH' position.
- b. With the gas control knob depressed, manually light the burner.
- c. Release the gas control knob after approximately 10-20 seconds after lighting the burner.
- d. The burner should stay alight - if not, repeat Steps (a to (c above.
- e. To achieve simmer control, depress the gas control knob and rotate between the 'HIGH' and 'LOW' positions to achieve the temperature required.

Turning 'OFF' the Open Burners

- a. When the main burner is not required, depress and turn the gas control knob clockwise back to the 'OFF' position. The 'MAIN' burner will extinguish.

Pilot and Flame Failure Option (PF-Models)

Lighting the Open Burners

These hobs are fitted with individual standing pilots for each open burner which allows the main burners to be turned 'ON' - 'OFF' without the need to manually re-light the burner each time that it is turned 'ON', as the burner will automatically light itself off the pilot burner.

Flame Failure Protection is incorporated for each burner by way of a thermo-electric system which will shut off the gas supply to that burner in the event that the burner goes out, so that un-burnt gas is not expelled.

- a. Select the burner required, depress and turn the corresponding gas control knob anti-clockwise to the 'PILOT' position.
- b. With the gas control knob depressed, manually light the pilot burner.
- c. Release the gas control knob after approximately 10-20 seconds after lighting the pilot burner.
- d. The pilot burner should stay alight - if not, repeat Steps (a to (c above.
- e. 'Full Flame' can now be achieved by depressing and rotating the gas control knob anti-clockwise to the first stop 'HIGH' flame position.
- f. Low flame can be achieved by depressing the gas control knob and rotating fully anti-clockwise to the 'LOW' flame position.
- g. To achieve simmer control, depress the gas control knob and rotate between the 'HIGH' and 'LOW' positions to achieve the temperature required.

Turning 'OFF' the Open Burners / Pilots

- a. To turn 'OFF' the main burner, but keep the pilot burner alight, rotate the gas control knob to the 'PILOT' position. The main burner will extinguish and the pilot will remain alight.
- b. To turn 'OFF' the 'PILOT', depress and turn the gas control knob clockwise back to the 'OFF' position. The 'PILOT' burner will extinguish.

Griddle

CAUTION:

The griddle plate temperature reaches over 300°C in hottest points during normal operation at 'Full Flame' setting.

These griddles are fitted with a pilot as a standard option and Flame Failure Protection, which is incorporated by way of a thermo-electric system for each main burner. Flame Failure Protection will shut off the gas supply to that burner in the event that the pilot for that burner goes out, so that un-burnt gas is not expelled. ***This is an important safety feature which is slowly becoming law throughout the world.***

Lighting the Griddle

- Depress the gas control knob and rotate anti-clockwise to the 'PILOT' position.
- With the gas control knob depressed, press the piezo ignition button to ignite the pilot burner. Repeat Items 1 to 2 until the pilot is lit.
- Release the gas control knob approximately 10-20 seconds after lighting the pilot.
- The pilot should now remain alight - if not, repeat Steps (a) to (c) above.
- 'Full Flame' can now be achieved by depressing and rotating the gas control knob anti-clockwise to the first stop.
- Low flame can be achieved by depressing the gas control knob and rotating fully anti-clockwise to the 'Low Flame' position.
- When the main burner is not required, depress and turn the gas control knob clockwise back to the 'OFF' position.

Turning 'OFF' the Griddle Burner / Pilot

- To turn 'OFF' the griddle, but keep the pilot burner alight, rotate the gas control knob to the 'PILOT' position. The griddle burner will extinguish and the pilot will remain alight.
- To turn 'OFF' the 'PILOT', depress and turn the gas control knob clockwise back to the 'OFF' position. The 'PILOT' burner will extinguish.

Oven Pilot Ignition

This oven is fitted with a pilot as a standard option and flame failure protection, which is incorporated by way of a thermo-electric system for the main burner. Flame failure protection will shut off the gas supply to the burner in the event that the pilot burner goes out, so that un-burnt gas is not expelled. ***This is an important safety feature which is slowly becoming law throughout the world.***

! IMPORTANT

DO NOT USE aluminium foil or trays directly on the cast iron sole plate(s). NEVER block or cover the openings on each side of the sole plate(s).

- Open the oven door.
- Depress the oven gas control knob and rotate anti-clockwise to the 'PILOT' position.
- While holding the oven gas control knob depressed, press the piezo ignition button to ignite the pilot burner. Repeat Items 1 and 2 until the pilot burner is lit.
- Release the gas control knob approximately 10-20 seconds after lighting the pilot.
- The pilot should now remain alight - if not, repeat Steps 2 to 3 above.
- Ensure that the pilot burner is alight by opening the pilot viewing covers and looking through the pilot burner viewing holes in the cast oven sole plate.

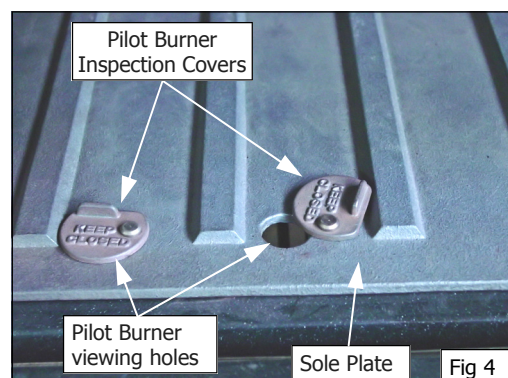

NOTE: Ensure that the pilot viewing covers are closed once the pilot is lit.

Operation

Oven - Main Burner / Thermostat

1. Ensure that the oven door is closed.
2. Turn 'ON' electrical power at the mains supply, the (white) power indicator light will illuminate on the oven control panel.
3. With the pilot burner alight, depress and rotate the oven gas control knob to the 'Main Flame' position. (This puts the gas valve in the 'Stand-By' position and control of the main burner is now carried out through the oven thermostat control).
4. Turn the oven thermostat to the desired oven temperature setting required, this will regulate the gas supply to the oven main burner.
5. The oven fan will start up and the oven main burner will ignite.
6. The amber heating indicator light will show that the oven main burner is 'ON' and the oven is heating. When the amber heating indicator light goes out, the oven has reached the pre-selected temperature, the burner will cycle 'OFF'.

Oven Fan

1. The fan is operational only when the oven thermostat is set to a temperature. The fan is controlled by a microswitch which in turn is controlled by the opening and closing of the oven door. The oven fan is operational only with the oven door closed.

Turning the Oven to 'Standby' (Pilot 'ON' Only)

1. To turn off the oven main burner / heating, set the oven thermostat to the '0' temperature position, this will turn the oven main burner 'OFF', but will leave the oven pilot burner 'ON'.
2. In this position the pilot burner will remain alight, but the oven main burner will not operate until the thermostat control knob is set to a temperature.
3. If oven pre-heating is required, set the thermostat control knob to temperature 190°C and allow 20 minutes before cooking in the oven to allow the oven to warm up.

Oven 'Shut-Down'

1. To 'Shut Down' the oven, turn the oven thermostat to the '0' position, the oven main burners will go out.
2. Turn the gas control valve to the 'OFF' position and this will extinguish the pilot burner. (To relight the pilot burner, refer to 'Oven Pilot Ignition' above).
3. Turn 'OFF' the electrical power at the mains supply, the (white) power indicator light will extinguish.

NOTE: If the main burner has recently been turned 'OFF', should you wish to re-light the oven, the interlock will not allow the gas valve to be turned to the main burner position until the interlock has reset (Approximately 1 minute). DO NOT FORCE THE GAS VALVE TO THE MAIN BURNER POSITION UNTIL THE INTERLOCK HAS RESET, as this will damage the gas control valve.

IMPORTANT

Should any abnormal operation like;

- ignition problems,
- abnormal burner flame,
- burner control problems,
- partial or full loss of burner flame in normal operation, be noticed, the appliance requires **IMMEDIATE** service by a qualified service person and should not be used until such service is carried out.

Cleaning and Maintenance

CAUTION:

Always turn off the gas and electrical supply before cleaning.
This appliance is not water proof.
Do not use water jet spray to clean interior or exterior of this appliance.

General

Clean the range regularly. A clean range looks better, will last longer and will perform better. Carbonised grease on the surface or between the trivets, griddle plates will hinder the transfer of heat from the cooking surface to the food. This will result in loss of cooking efficiency.

NOTE: Each griddle option can be supplied with a scraper tool and a pack of blades for cleaning the griddle surface. These are not supplied with the griddle and have to be purchased separately. Refer to the 'Replacement Parts List' at the rear of this manual.

WARNING:

THE BLADES FITTED TO THE SCRAPER TOOL ARE EXTREMELY SHARP AND ARE TO BE USED WITH CARE.

DO NOT use water on the trivets, burners and griddle plates while these items are still hot as warping and cracking may occur. Allow these items to cool down and then remove for cleaning. The entire trivets, griddle plates and burner caps can be dismantled for cleaning.

NOTE:

- **DO NOT** use abrasive detergents, strong solvents or caustic detergents as they could corrode or damage the range.
- In order to prevent the forming of rust on the trivets, griddle plate (If fitted) and burners, ensure that any detergent or cleaning material has been completely removed after each cleaning. The appliance should be switched on briefly to ensure the griddle plates become dry. Oil or grease should be spread over the griddle surface in order to form a thin protective greasy film.

To keep your range clean and operating at peak efficiency, follow the procedures shown below:-

After Each Use

1. Clean the griddle with a scraper tool to remove any food debris.

CAUTION:

Always ensure that an even pressure is applied over the whole surface of the scraper tool when using on the flat surface of the griddle, to prevent scoring of the surface.

NEVER bang the sharp edge of the scraper tool on the flat surface of the griddle as this will damage the surface and invalidate the warranty.

2. Always ensure that the scraper tool blades are changed regularly to ensure that the scraper tool works efficiently and prevents damage to the griddle plate surface.
3. Clean the range castings with a stiff nylon brush or a flexible spatula to remove any food debris.

Cleaning and Maintenance

Daily Cleaning

1. The grease tray(s) should be checked and emptied frequently to prevent overflow and spillage. Remove the grease tray(s) while still warm so that the grease is in a liquid state. Empty any grease from the trays and wash thoroughly in the same manner as any cooking utensil.
2. Clean the control panel with a damp cloth lightly moistened with a solution of mild detergent and water. Wipe dry with a clean dry cloth.
3. Remove the burner caps and bases, the trivets and thoroughly clean the splash back, interior and exterior surfaces of the range with hot water, a detergent solution and a soft scrubbing brush.
4. Brush the griddle surface with a soft bristled brush. Any carbon deposits should be removed using a scraper tool followed by wiping with a cloth to prevent accumulation of food deposits.
5. Dry the range thoroughly with a dry cloth and polish with a soft dry cloth.

Weekly Cleaning

NOTE:

- If the range usage is very high, we recommend that the weekly cleaning procedure is carried out on a more frequent basis.
- Ensure that protective gloves are worn during the cleaning process.
- DO NOT use harsh abrasive detergents, strong solvents or caustic detergents as they will damage the range, burners and plates
- DO NOT use water on the trivets, griddle plates and burners while they are still hot as cracking may occur. Allow these items castings to cool and remove for cleaning.
- DO NOT clean the burners in a dishwasher.

Range Cooking Area

- a. Clean the range cooking area using a soft cloth moistened with a mild detergent and hot water solution.
- b. Baked on deposits or discolouration may require a good quality stainless steel cleaner or stainless steel wool. Always apply cleaner when the appliance is cold and rub in the direction of the grain.
- c. It should not be necessary to remove the splash guards covering the burner manifolds for cleaning purposes. These can be cleaned in situ.
- d. Remove the grease tray and clean with a mild anti bacterial detergent and hot water solution using a soft bristled brush.
- e. Dry the grease tray thoroughly with a dry cloth.

Griddle Plate - (Steel)

NOTE: In order to prevent the forming of rust on the griddle plate, ensure the detergent or cleaning material has been entirely removed after each cleaning process. The appliance should be switched on briefly to ensure the griddle plates become dry. Oil or grease should be spread over the griddle surface in order to form a thin protective greasy film.

CAUTION:

Always ensure that an even pressure is applied over the whole surface of the scraper tool when using on the flat surface of the griddle, to prevent scoring of the surface.

NEVER bang the sharp edge of the scraper tool on the flat surface of the griddle as this will damage the surface and invalidate the warranty.

- a. Remove and clean the grease tray frequently to prevent over spills.
- b. Clean the griddle surface (optional) thoroughly with a scraper tool or a wire brush. If necessary use a griddle stone or a scotch bright pad on the griddle surface to remove stubborn carbon and deposits.
- c. A scraper tool can be used for the removal of stubborn carbon and deposits.
- d. Occasionally bleach the griddle plate with vinegar when the plate is cold.

- e. Clean with hot water, a mild detergent solution and a scrubbing brush. Dry all components thoroughly with a dry cloth.
- f. The griddle should be switched on briefly to ensure that the griddle plate becomes dry. A thin smear of cooking oil should be spread over the grates and griddle plate in order to form a protective film.

Trivets and Burners

- a. Remove the trivets from the top of the appliance, taking note that the trivets are manufactured with a lip on one edge, the lip must always be fitted to the outer edge (front and back) of the range. (See Fig 10).
- b. Remove the burner cap and burner bowl (these are a loose fit to the manifold, see Fig 5) from the top of the gas manifold, taking care not to damage the thermocouple (and pilot tube - 'PF' Option) fitted through the manifold splash guard. (See Fig 8 for 'F' Option and Fig 9 for 'PF').
- c. The trivets and burners should be cleaned with a mild detergent and hot water solution using a soft bristled brush. Dry thoroughly with a dry cloth.

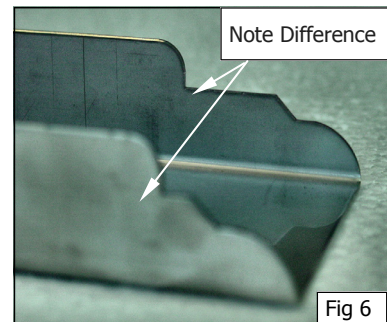
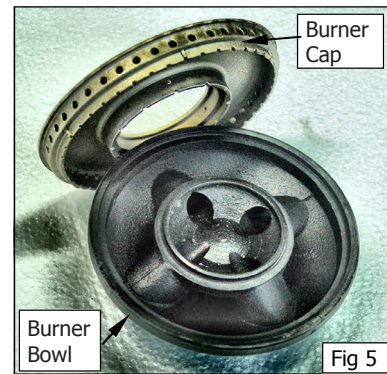

Trivet Supports

- a. Remove all the trivet supports from the top of the appliance. Take note of the orientation of the trivet support when removing. The trivet support front end side rail profiles are different from the rear end side rail profiles. (See the Note shown at Item a. in 'Re-Fitting the Components to the Range' overleaf and Figure 6 opposite).
- b. The trivet supports should be cleaned with a mild detergent and hot water solution using a soft bristled brush.
- c. Dry the trivet supports thoroughly with a dry cloth.

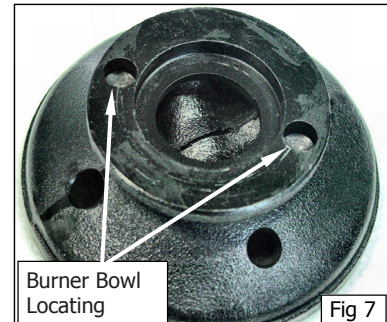

Stainless Steel Surfaces

- a. With the griddle plates and burners removed, clean the interior and exterior surfaces of the range with hot water, a mild detergent solution and a soft scrubbing brush. Note that the gas control knobs are a push fit onto the gas control valve spindles and can be removed to allow cleaning of the front control panel.
- b. Baked on deposits or discolouration may require a good quality stainless steel cleaner or stainless steel wool. Always apply cleaner when the appliance is cold and rub in the direction of the grain.
- c. It should not be necessary to remove the splash guards covering the burner manifolds for cleaning purposes. These can be cleaned in situ.
- d. Dry all components thoroughly with a dry cloth and polish with a soft dry cloth.
- e. To remove any discolouration, use an approved stainless steel cleaner or stainless steel wool. Always rub in the direction of the grain.
- f. Remove the grease tray and clean with a mild anti bacterial detergent and hot water solution using a soft bristled brush.
- g. Dry the grease tray thoroughly with a dry cloth.
- h. Dry all components thoroughly with a dry cloth and polish with a soft dry cloth.

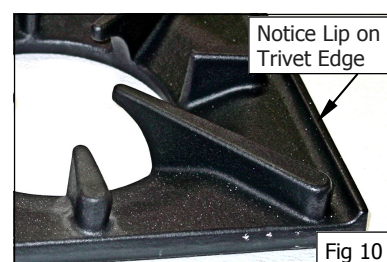
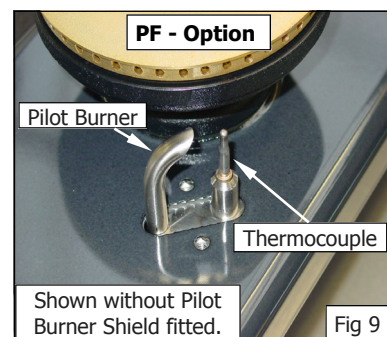
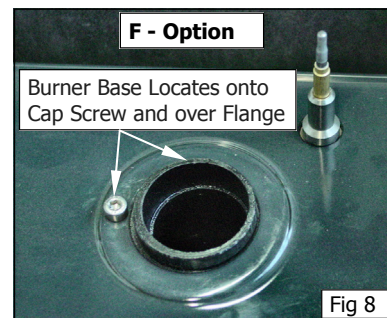

Cleaning and Maintenance

Re-Fitting the Components to the Range

- a. Refit the trivet supports to the range, ensuring that the trivet supports are correctly fitted.

NOTE: It is imperative that the trivet supports are correctly re-fitted to the appliance to ensure that the trivets locate correctly and sit flush and level. NOTE that the trivet support front end, side rail profiles are different at either side and only one of the side rails seat into the cut-out in the range top, where as the rear end of the trivet support side rail profiles are the same and have 2 cut-outs to locate into.

- b. Refit the burner bowls onto the manifolds protruding through the splash guards, taking care not to damage the thermocouple which is close to the manifold.

NOTE: The burner bowl (cast item) has 2 locating holes drilled into the base flange, these are to locate the burner bowl to the cap screw on the gas manifold when re-fitting the burner bowl onto the gas manifold (See Fig 7 and Fig 8 on the previous page).

- c. Refit the burner caps (cast brass) onto the burner bowls already fitted to the manifold. These are a loose fit into the burner bowls.
- d. Refit the trivets to the top of the appliance, taking note that the trivets are manufactured with a lip on one edge, the lip must always be fitted to the outer edge (front and back) of the range. (See Fig 9 on the previous page).
- e. Refit the grease tray(s) to the range.

Oven Interior

- a. Do not use wire brushes, steel wool or other abrasive materials to clean the oven interior.
- b. Clean the oven regularly with a good quality domestic oven cleaner.
- c. Once a week, remove and clean any built up of grease etc. from the oven racks and the bottom spill over cover.
- d. Dry the oven thoroughly with a dry cloth and polish with a soft dry cloth.

Periodic Maintenance

NOTE: All maintenance operations should only be carried out by a qualified service person.

To achieve the best results cleaning must be regular and thorough and all controls and mechanical parts should be checked and adjusted periodically by a qualified service person. If any small faults occur, have them attended to promptly. Don't wait until they cause a complete breakdown. It is recommended that the appliance is serviced every 6 months.

Gas Control Valve Re-Greasing

The gas control valve should be dismantled and greased every 6 months to ensure the correct operation of the gas control valve.

To carry out this operation;-

- a. Remove the gas control knobs from the gas tap spindles by pulling the knobs away from the control panel.
- b. Remove the drip tray from the appliance.
- c. Remove the two screws on the underside of the control panel, securing the control panel to the hob.
- d. Remove the control panel from the front of the appliance.
- e. Remove the 2 screws holding shaft plate to gas control body and remove control shaft and plate. (See Fig 11). Note orientation of shaft for correct re-assembly.
- f. Using needle nose pliers or similar, pull out gas control spindle, again noting its orientation.
- g. Apply a suitable high temperature gas cock grease or lubricant such as ROCOL - A.S.P (Anti scuffing paste) / Dry Moly Paste to the outside of the spindle. (See Fig 12).
- h. Replace spindle and re-assemble the gas control in reverse order.
- i. Refit the control panel to the appliance and secure with 2 screws.
- j. Refit the knobs to the gas control valve spindles.

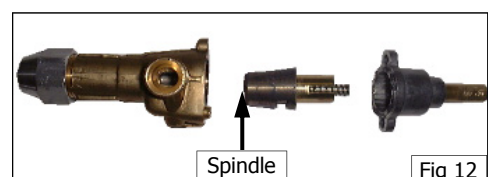
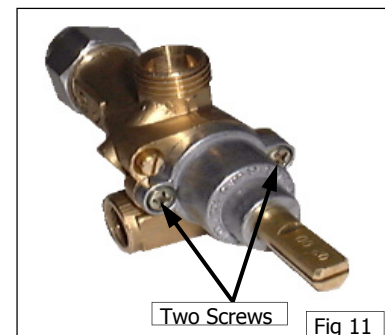

Fault Finding

This section provides an easy reference guide to the more common problems that may occur during the operation of your appliance. The fault finding guide in this section is intended to help you correct, or at least accurately diagnose problems with your equipment.

Although this section covers the most common problems reported, you may encounter a problem not covered in this section. In such instances, please contact your local authorised service agent who will make every effort to help you identify and resolve the problem. Please note that the service agent will require the following information:-

- **The Model Trade Name and the Serial Number of the Appliance. (Both can be found on the Technical Data Plate located on the appliance.**

Fault	Possible Cause	Remedy
Pilot won't light.	No gas supply. Blocked pilot injector.	Ensure gas isolation valve is turned on, and that bottles are not empty. Call the service provider.
Pilot goes out when gas control knob released.	Releasing knob before the thermocouple has heated. Pilot flame too small. - Gas pressure too low. - Partially blocked pilot injector. Thermocouple connection to the gas control is loose or faulty. Thermocouple faulty. Electromagnet in the rear of the gas control unit is faulty.	Hold knob in for at least 20 seconds following ignition of the pilot. Clean or replace the pilot injector. Tighten the thermocouple connection. Check that the thermo couple is producing between 20-30mV. Inspect and replace if not in good working order. Call the service provider.
Main burner will not light.	Incorrect supply pressure. Faulty gas control.	Call the service provider. Call the service provider.
Piezo Ignition spark is being generated but not sparking from the ignition electrode to the pilot burner hood. (On Griddle and Oven Options).	HT lead damaged or broken. Check that the ignition electrode is not cracked and is correctly positioned. Piezo igniter faulty.	Repair or replace the HT lead. Re-position or replace the ignition electrode. Replace the piezo igniter. Call the service provider.

NOTE: Components having adjustments protected (e.g. paint sealed) by the manufacturer, are only allowed to be adjusted by an authorised service agent. They are not to be adjusted by an unauthorised service person.

Wiring Schematic

G54 / G56 / G58

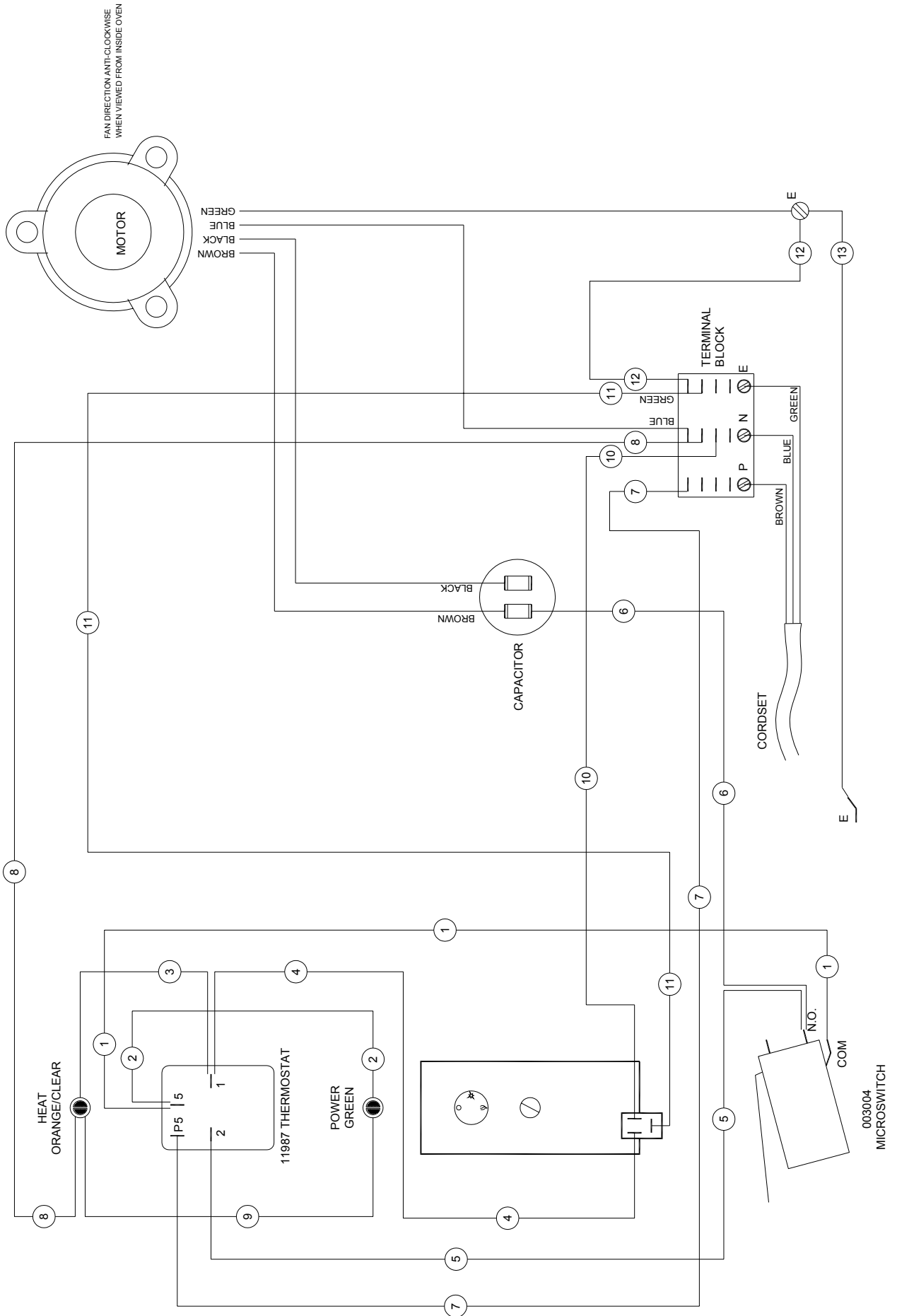

Conversion Procedure

CAUTION:

Ensure that the appliance is isolated from the electrical and gas supply before commencing servicing.

NOTE:

- These conversions should only be carried out by qualified persons. All connections must be checked for leaks before re-commissioning the appliance.
- Adjustment of components that have adjustments/ settings sealed (e.g. paint sealed) can only be adjusted in accordance with the following instructions and shall be re-sealed before re-commissioning this appliance.
- For all relevant gas specifications refer to the table at the end of this section.

Open Burners ('F' - Flame Failure Option)

1. Turn off the gas supply at the main supply.
2. Remove the trivets from the top of the appliance, taking note that the trivets are manufactured with a lip on one edge, the lip must always be fitted to the outer edge (front and back) of the range. (See Fig 18).
3. Remove the burner cap and burner bowl (these are a loose fit to the manifold) (See Fig 13) from the top of the gas manifold, taking care not to damage the thermocouple fitted through the manifold splash guard.
4. Remove all the trivet supports from the top of the appliance. **Note the orientation of the trivet support when removing. The front end side rail profiles are different from the rear end side rail profiles. (See Fig 14).**
5. Remove the splash guard covering the burner manifolds by unscrewing the two allen headed screws. (See Fig 15). Carefully remove the splash guard taking care not to damage the thermocouples.
6. Unscrew and remove the injectors (13mm or 1/2 A/F) from the gas cocks. (See Fig 16).
7. Determine the correct injector sizes for the corresponding gas from the rating plate affixed to the bottom right hand corner of the bottom sill.
8. Replace with correct size injectors. Refer to 'Gas Specifications Table' for injector sizes.
9. Refit the splash guards over the gas cocks taking care not to damage the thermocouples and secure in position with the 2 allen headed screws. (See Fig 15).
10. Refit the burner bowls and caps onto the manifolds protruding through the splash guards, taking care not to damage the thermocouple. Take note that the burner bowl (cast item) has 2 locating holes drilled into the base flange, (See Fig 17) these are to locate the burner bowl onto the allen headed screw that secures the splash guard to the gas manifold. (See Fig 15).
11. Turn on the gas supply at the mains, re-light the burners and check the flame size on the simmer 'LOW' position.

NOTE: The right hand gas control valve supplies the rear burner and the left hand gas control valve supplies the front burner.

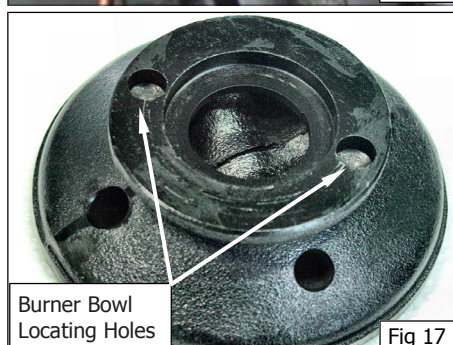
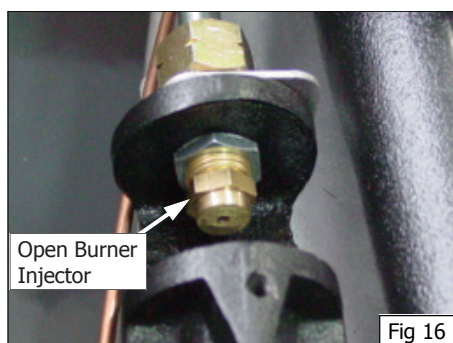
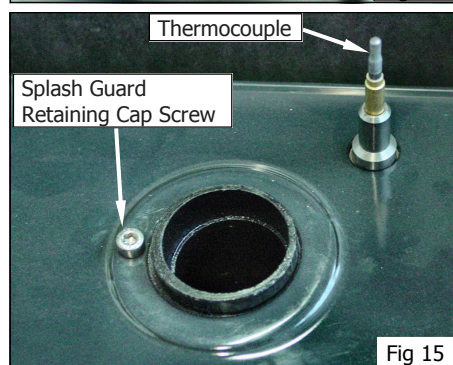
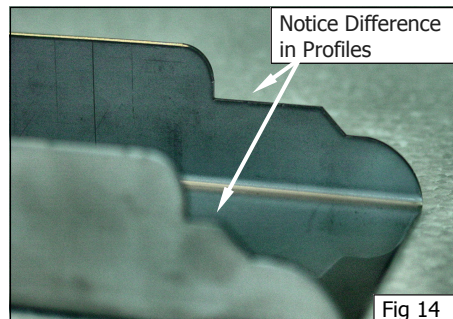
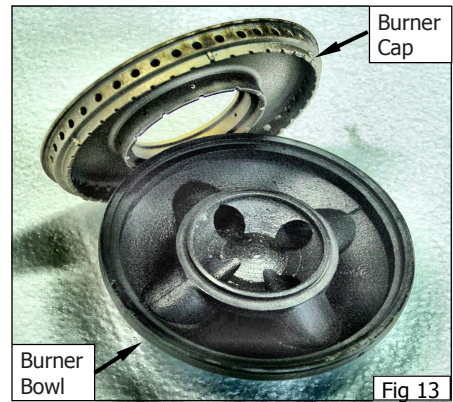

Gas Conversion and Specifications

12. Refit all the trivet supports to the top of the appliance. Note the orientation of the trivet support when re-fitting. The trivet support front end side rail profiles are different from the rear end side rail profiles. (See Fig 14).
13. Refit the trivets to the top of the appliance taking note that the trivets are manufactured with a lip on one edge, the lip must always be fitted to the outer edge (front and back) of the cook top. (See Fig 18).

Low Fire Adjustment

- a. To adjust the open burner low fire adjustment, remove the gas control knobs from the front of the control panel.
- b. Adjust the low fire adjustment screw on the open burner gas control valves to obtain the desired flame size. (See Fig 19).

NOTE: The “Low Fire Screw” should be sealed with coloured paint on completion of the low fire adjustment.

Open Burners ('PF' - Pilot & Flame Failure Option)

1. Turn 'OFF' the gas supply at the main supply.
2. Remove the trivets from the top of the appliance, taking note that the trivets are manufactured with a lip on one edge, the lip must always be fitted to the outer edge (front and back) of the cook top. (See Fig 18).
3. Remove the burner caps and burner bowls (these are a loose fit to the manifold) from the top of the gas manifold.
4. Remove all the trivet supports from the top of the appliance. Note the orientation of the trivet supports when removing. The trivet support front end side rail profiles are different from the rear end side rail profiles. (See Fig 14).
5. Remove the pilot burner shields from over the pilot burners / thermocouples by removing the 2 screws securing the pilot burner shields to the splash guards. (See Fig 21).
6. Remove the splash guards covering the burner manifolds by unscrewing the two allen headed screws. Carefully remove the splash guards taking care not to damage the pilot burner tubes and thermocouples protruding through the splash guard.

Main Injectors

- a. Unscrew and remove the main injectors (1/2 A/F) from the gas cocks. (See Fig 22).
- b. Replace with the correct size injectors. Refer to the 'Gas Specifications' table at the end of this section and the Rating Plate attached to the underside of the right hand side, front oven lower trim for correct injector sizes for the corresponding gas.

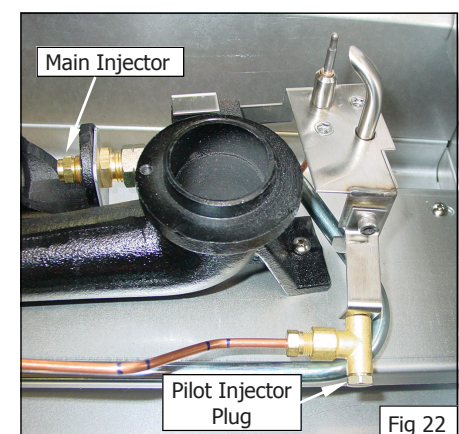
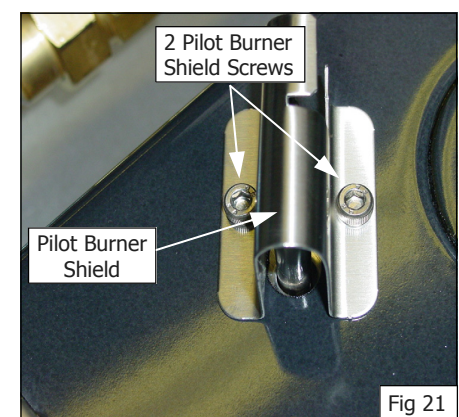
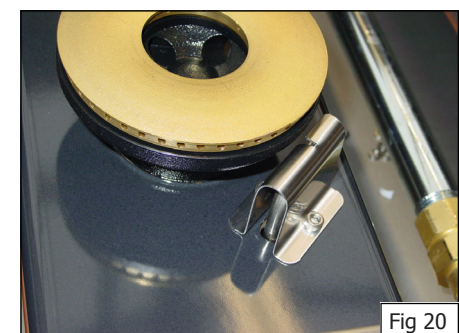
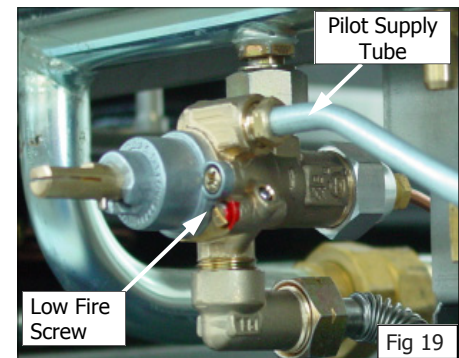
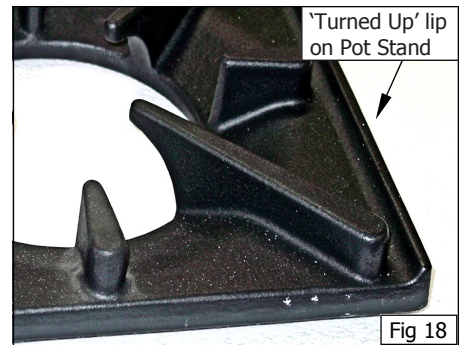

Pilot Injectors

- Unscrew and remove the Pilot Injector Plug from the fitting at the end of the pilot injector tube using a 11 mm A/F spanner. (See Fig 23).
- Using a flat bladed screwdriver, unscrew and remove the pilot injector from the pilot injector housing.

NOTE Take care not to lose the spring fitted in front of the injector.

- Remove existing pilot injector and replace with the correct size pilot injector for the gas type being used. Refer to the 'Gas Specifications' table at the end of this section, for correct pilot injector sizes.
- Refit the spring and the correct pilot injector to the pilot injector housing.
- Screw the pilot injector fully home using a flat blade screwdriver and refit the pilot injector plug to the pilot injector housing and tighten in place using a 11 mm A/F spanner. (See Fig 23).
- Refit the splash guard over the gas cocks taking care not to damage the thermocouples and pilot burner tubes. Secure in position with the 2 allen headed screws. (Note that the splash guard for 'PF' models has a different cut-outs for pilot burner tubes. See Fig 24 & Fig 25).
- Refit the pilot burner tube shields over the pilot burner tubes / thermocouples and secure in place with the 2 securing screws. (See Fig 21).
- Refit the burner caps and burner bowls onto the manifolds protruding through the splash guards. Take note that the base part of the burner bowl has 2 locating holes drilled into the base flange, (See Fig 17).these are to locate the burner bowl onto the allen headed screws that secure the splash guard to the gas manifold. (See Fig 15).
- Refit all the trivet supports to the top of the appliance. Note the orientation of the trivet support when re-fitting as the front end side rail profiles are different from the rear end side rail profiles. (See Fig 14).
- Refit the trivets to the top of the appliance taking note that the trivets are manufactured with a lip on one edge, the lip must always be fitted to the outer edge (front and back) of the cook top. (See Fig 18).

Low Fire Adjustment

- To adjust the open burner low fire adjustment, remove the gas control knobs from the front of the control panel.
- Adjust the low fire adjustment screw on the open burner gas control valves to obtain the desired flame size. (See Fig 26).

NOTE: The "Low Fire Screw" should be sealed with coloured paint on completion of the low fire adjustment.

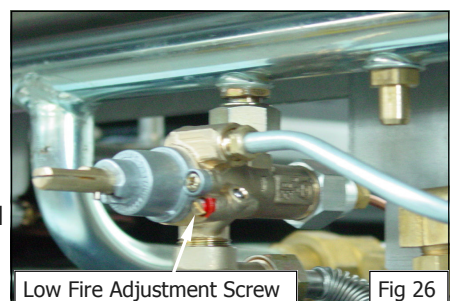
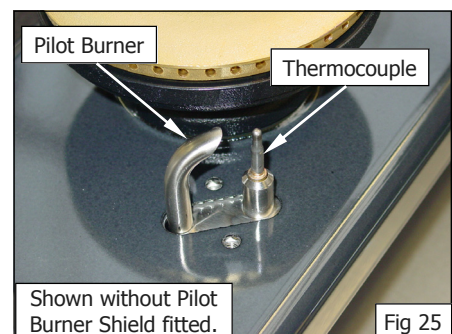
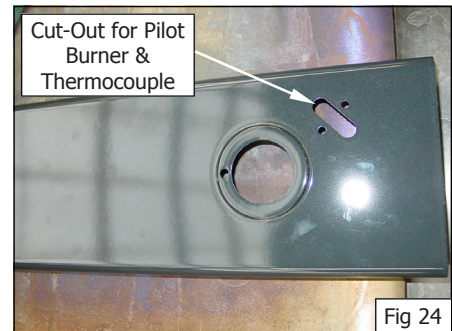
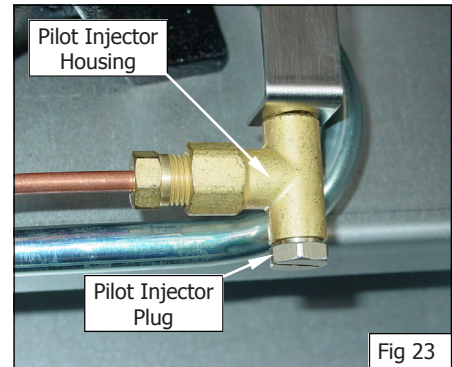

Gas Conversion and Specifications

Gas Griddle

Pilot Burner

- With the gas supply turned off at the main supply, remove the griddle plate section by lifting it straight off the cook top.
- Remove the gas control heat shield from around the griddle burner, this is just a push in fit.
- Disconnect the thermocouple and the piezo igniter from the mounting bracket. (For access purposes). (See Fig 28).
- Disconnect the pilot supply tube from the pilot burner with a 13 mm (1/2") spanner. (See Fig 28).
- Remove existing pilot injector and replace with the correct size for the gas being used. Refer to the 'Gas Specifications' table at the end of this section, for correct injector sizes.
- Re-connect the pilot supply tube to the pilot burner with a 13 mm (1/2") spanner. (See Fig 28).
- Refit the piezo igniter and thermocouple to the mounting bracket. (See Fig 28).
- Repeat Items a) to g) for all griddle pilot burners.

Main Burner

- Remove the main burner from the burner box by removing the securing screw at the end of the burner, this will reveal the main injector. (See Fig 29).
- Remove and replace the main burner injectors with correct size injectors. Refer to the 'Gas Specifications' table at the end of this section, for correct injector sizes.
- Refit the burner to the griddle burner box.
- Refit the gas control heat shield to the griddle burner box.
- Refit the griddle plate section to the top of the cook top.
- Repeat Items a) to e) for all griddle main burners.
- Turn 'ON' the gas supply at the mains, re-light the griddle burners and check the flame size on the 'LOW' flame position.

Low Fire Adjustment

- To adjust the griddle burner 'LOW' fire adjustment, remove the gas control knob from the front of the control panel.
- Adjust the 'Low Fire' adjustment screw on the griddle gas control valve (Refer to Fig 30) only to obtain the desired flame size.

NOTE: The "Low Fire Screw" should be sealed with coloured paint on completion of the low fire adjustment.

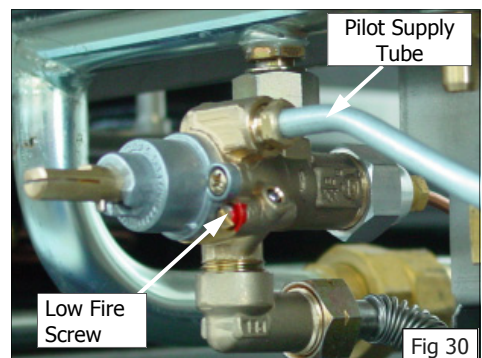
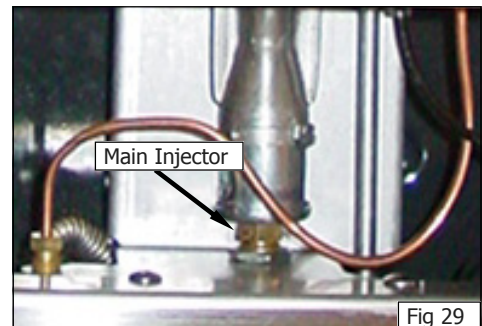
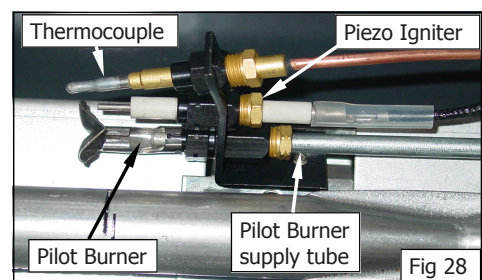
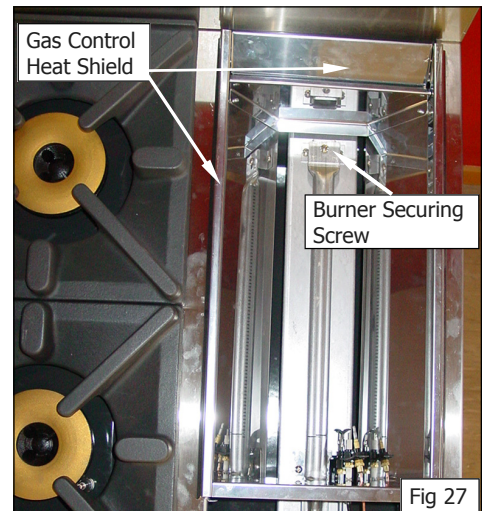

Gas Conversion and Specifications

Oven

Main Injector

- With the gas supply turned off at the main supply, unscrew and remove the 6 screws securing the lower lintel to the front of the oven.
- Remove the lintel from the oven.
- Open the oven door and remove the cast sole plate from inside the oven. (Refer to Fig 31).
- Remove the screw securing the oven burner to the floor of the oven. (Refer to Fig 32).
- Slacken the 2 screws securing the burner clamp bracket at the front of the oven, (Refer to Fig 34), this will allow the burner to be removed out of the front of the oven.
- The main burner injector will now be exposed and can be unscrewed and removed. (Refer to Fig 33).
- Remove the main injector and replace with the correct size injector. (Refer to the 'Gas Specifications' table at the rear of this section).
- Refit the main burner and secure the burner and burner clamp bracket to the oven. (Refer to Fig 32 and Fig 34).

Pilot Injector

- To remove the oven pilot injector, remove the two screws securing the pilot burner bracket to the front of the oven. (Refer to Fig 34).
- Remove the pilot burner bracket from the front of the oven (Refer to Fig 35), unscrew and remove the piezo igniter from the mounting bracket to allow better access to the pilot supply tube.
- Unscrew the hex nut holding the pilot supply tube to the rear of the pilot assembly.
- Withdraw the pilot injector from the pilot assembly.
- Replace the pilot injector with the correct sized injector for the gas type being used and re-connect the pilot supply tube to the pilot assembly.
- Refit the piezo igniter to the mounting bracket.
- Refit the pilot burner mounting bracket to the front of the oven and secure to the front of the oven with 2 screws. (Refer to Fig 34 and Fig 35).

Low Fire (Convection Oven):

Please note that there is no low fire adjustment on the gas control valve for the GC Oven.

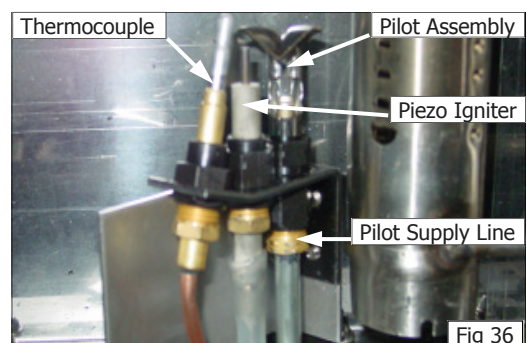
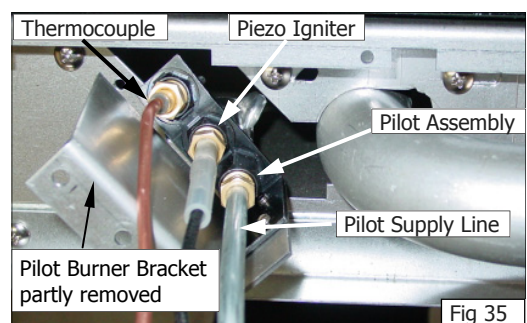
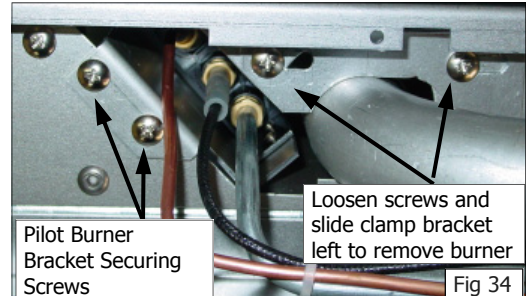
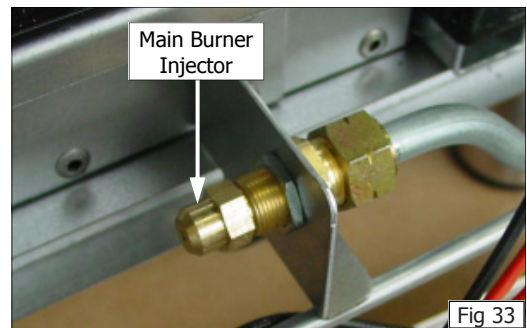
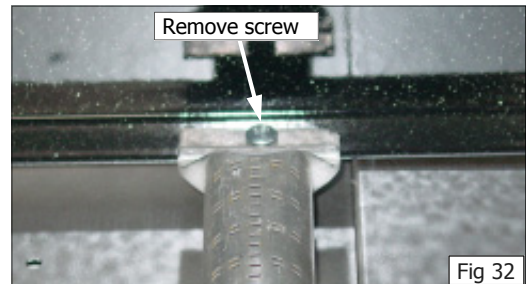
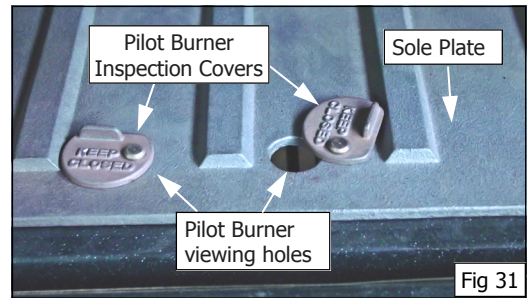

Gas Conversion and Specifications

Gas Regulator

NOTE: The regulator supplied is convertible between Natural Gas and LPG, but its outlet pressure is fixed ex-factory and is NOT to be adjusted.

1. Ensure that the gas and electrical supply are turned off.

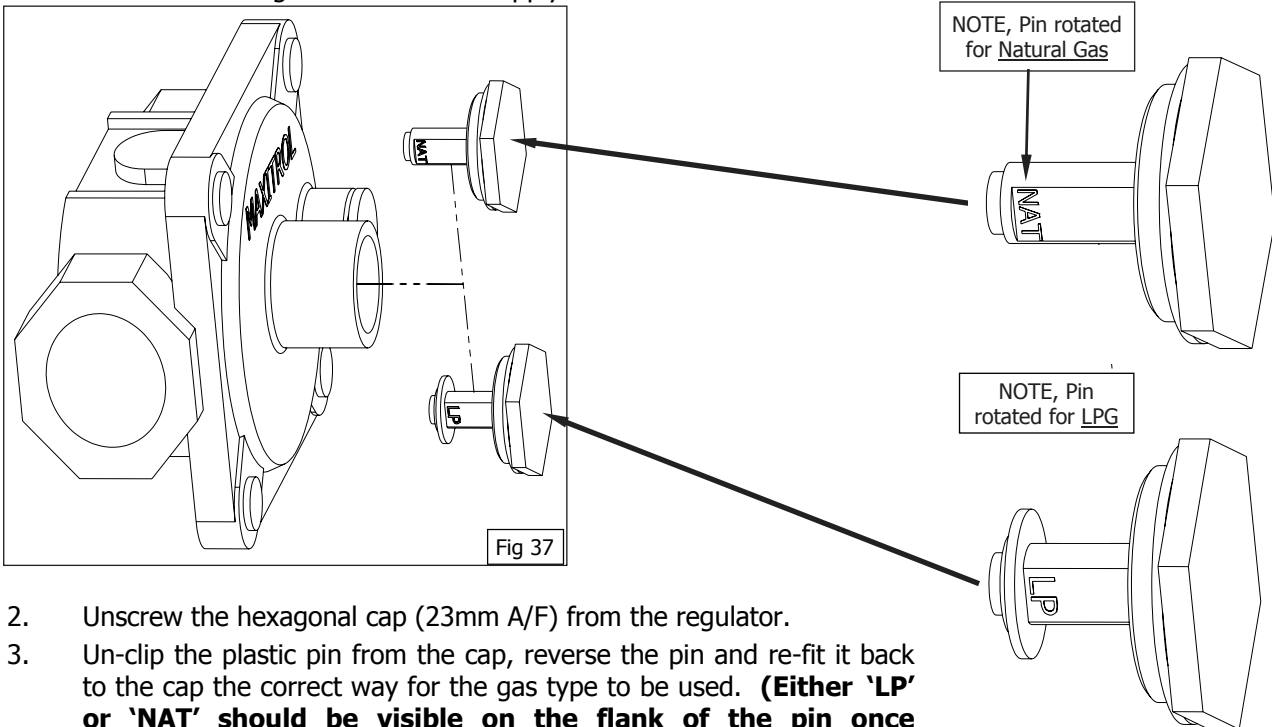

2. Unscrew the hexagonal cap (23mm A/F) from the regulator.
3. Un-clip the plastic pin from the cap, reverse the pin and re-fit it back to the cap the correct way for the gas type to be used. **(Either 'LP' or 'NAT' should be visible on the flank of the pin once re-fitted to the cap).**
4. Screw the cap back into the regulator.

Gas Type Identification Label

On completion of the gas conversion, replace gas type identification labels, located at:-

- The rear of the appliance, above the gas connection.
- beside the rating plate.

Commissioning

Before leaving the converted installation;

1. Check all gas connections for leakages using soapy water or other gas detecting equipment.

WARNING:

DO NOT USE A NAKED FLAME TO CHECK FOR GAS LEAKAGES.

2. Check the following functions in accordance with the operating instructions specified in the "Operation" section of this manual.

- Light the Pilot Burners.
- Light the Main Burners.
- Check the Low Fire burner operation.
- Check the High Fire burner operation.
- Ensure that all the controls operate correctly.
- Ensure that the operating pressure remains correct.



3. Ensure any adjustments done to components that have the adjustments / settings sealed (e.g. paint sealed) are re-sealed.

NOTE: If for some reason it is not possible to get the appliance to operate correctly, shut off the gas supply and contact the supplier of this appliance.

Gas Conversion and Specifications

Gas Specifications

- Australia / New Zealand



		Natural Gas	LP Gas (Propane)
Open Burner	Main Burner Injectors	Ø 2.45 mm	Ø 1.50 mm
	Pilot Burner ('PF' Option Only)	0.30	0.20
Griddle	Main Burner	Ø 2.10 mm	Ø 1.30 mm
	Pilot Burner	0.35	0.23
	Burner Aeration Setting	Fully open	Fully open
Oven	Main Burner	Ø 2.60 mm	Ø 1.60 mm
	Pilot Burner	0.35	0.23
	Burner Aeration Setting	Fully open	Fully open
Supply Pressure		1.13 - 3.40 kPa	2.75 - 4.50 kPa
Operating Pressure		0.95 kPa (*)	2.6 kPa (*)
Gas Regulator Cap Screw			

- CE Only

Appliance Classification

Category: **II_{2H3P} (20, 30 / 37).**

Flue Type: **A₁.**

		Natural Gas (G20)	Propane (G31)
Open Burner	Main Burner Injectors	Ø 2.30 mm	Ø 1.40 mm
	Pilot Burner ('PF' Models Only)	0.30	0.20
Griddle	Main Burner	Ø 2.10 mm	Ø 1.30 mm
	Pilot Burner	0.35	0.23
	Burner Aeration Setting	Fully open	Fully open
Oven	Main Burner	Ø 2.60 mm	Ø 1.60 mm
	Pilot Burner	0.35	0.23
	Burner Aeration Setting	Fully open	Fully open
Supply Pressure		20 mbar	30 / 37 mbar
Operating Pressure		9.5 mbar	26 mbar
Gas Regulator Cap Screw			

* The burner operating pressure is to be measured at the manifold test point with two burners operating at the 'High' setting. The operating pressure is ex-factory set through the appliance regulator and is not to be adjusted, apart from when carrying out gas conversion, if required. (Refer to the 'Gas Conversion' section for details).

Replacement Parts List

Replacement Parts List

IMPORTANT:

Only genuine authorized replacement parts should be used for the servicing and repair of this appliance. The instructions supplied with the parts should be followed when replacing components.

For further information and servicing instructions, contact your nearest authorized service branch (contact details are as shown on the reverse of the front cover of this manual).

When ordering replacement parts, please quote the part number and the description as listed below. If the part required is not listed below, request the part by description and quote model number and serial number which is shown on the rating plate.

Cook Top

Open Burners

227018	Burner Bowl.		
227017	Burner Cap.		
030245	Injector	(Nat. Gas)	Ø 2.45 mm.
030150	Injector	(LP Gas [Propane])	Ø 1.50 mm.
030230	Injector	(Natural Gas - G20)	Ø 2.30 mm (UK Only).
030140	Injector	(Propane - G31)	Ø 1.40 mm (UK Only).
026134	Pilot Injector	(Nat Gas)	0.30.
026136	Pilot Injector	(LP Gas [Propane])	0.20.
229442	Pilot Bracket Assembly.		
229444	Pilot Burner Shield.		
227379	Knob - Open Burner	(Standard).	
227378	Knob - Open Burner	(with Pilot).	
227403	Gas Control	(with Pilot and Flame Failure).	
227405	Gas Control	(With Flame Failure).	
228167	Thermocouple - Front.		
228166	Thermocouple - Rear.		

Griddle

014105	Burner.		
032210	Injector	(Nat. Gas)	Ø 2.10 mm.
032130	Injector	(LP Gas [Propane])	Ø 1.30 mm.
026488	Pilot Orifice	(Nat. Gas)	0.35.
019217	Pilot Orifice	(LP Gas [Propane])	0.23.
227403	Gas Control	(with Flame Failure and Pilot).	
227378	Knob - Griddle.		
019215	Pilot Burner.		
019428	Thermocouple.		
227508	Piezo Ignitor.		
228047	Piezo H.T. Lead.		
018744	Piezo Ignition Electrode.		
228288	Grease Tray	(Griddle Plates).	

Replacement Parts List

Oven

232234	Knob Thermostat 80-300°.		
227933	Oven Burner.		
018691K	Oven Pilot.		
020253	Oven Thermocouple.		
018743	Thermocouple Spacer.		
032260	Oven Burner Injector	(Nat Gas)	Ø 2.60 mm.
032160	Oven Burner Injector	(LPG)	Ø 1.60 mm.
026488	Pilot Injector	(Nat. Gas)	0.35.
019217	Pilot Injector	(LPG)	0.23.
011987	Thermostat.		
020103	Gas Control.		
227508	Piezo Ignitor.		
019407	H.T Lead.		
019479K	Motor Kit.		
010866	Cooling Disc.		
228116	Fan 200 x 40 mm.		
010909	Motor Capacitor 4µf.		
026160	Terminal Block - Mains.		
228704	Door Spring Kit.		
227963	Indicator Neon Amber.		
228922	Indicator Neon White.		
228938	Door Microswitch.		
230268	Pilot Viewing Hole Lid.		
748001	Taptite Screw M5 x 16.		
044018	Nut M5 Glenloch Locknut.		

General

227014	Pot Stand/Trivet.		
230282	Spill Tray - 750 mm	(G54 Series).	
230273	Spill Tray - 450 mm	(G56 Series).	
230277	Spill Tray - 600 mm	(G58 Series).	
227892	Side Rack LH.		
227893	Side Rack RH.		
023068	Side Rack Screw.		
232350	Baffle.		
227896	Oven Rack	(G56 / (G58 Series).	
228106	Oven Rack	(G54 Series).	
227850	Adjustable Leg - 150 mm.		
229674	Rear Roller Assy.		

Regulator

228531	Regulator (Natural Gas / LP Gas [Propane] Convertible) ¾" BSP F/F.
--------	--

Gas Conversion Kits

Models		Gas Type to Convert to			
		Australia / New Zealand Only		UK Only	
		Nat. Gas (G20)	LPG (Propane) (G31)	Nat. Gas	LPG
'F' Models	G54	231885	231884	231909	231908
	G56	231889	231888	231911	231910
	G58	231893	231892	231913	231912
'pF' Models	G54	231897	231896	231915	231914
	G56	231901	231900	231917	231916
	G58	231905	231904	231919	231918

Replacement Parts List

Accessories

228566	Griddle Scraper Tool.
228567	Smooth Plate Scraper Blades (Pack of 5 blades).
228568	Ribbed Plate Scraper Blade (Individual Blade).
228797	750 mm Plinth Kit.
228800	900 mm Plinth Kit.
228804	1200 mm Plinth Kit.

